



Technical Manual of Wall Mounted Energy Recovery Ventilator



BEAIR-WM100-Pm2.5

Attention

Please read this manual carefully before using the equipment



Contents

Accessories List-----	1
Safety Attentions-----	2
Product Introductions -----	3
Specifications and Operation Instructions-----	4
Operation Instructions-----	4~7
WIFI Connection-----	8~9
Installation Instructions-----	10~12
Maintenance-----	13~14
Failure Diagnose-----	15

Accessories List











The package includes the following items. Please check when opening the box:

1. Ventilator unit 1 set
2. Operation manual 2 piece (English and French)
3. And the below listed parts

			
Installation panel 1 pc	Power cable 1 pc	Remote control 1 pc	PVC Ducts 2 pcs
			
OA and EA Side/Back cover 2pcs	Air vent flange 2 pcs	Air inlet grille 1 pc	Air outlet grille 1 pc
			
Rain proof cover 2pcs	Rubber sealing ring 2pcs	Back seal ring 2 pcs	Side sealing ring 2 pcs
			
Knock-on anchor bolt 5 sets	Screws M3x6 and Nut M3 8sets	Tapping screws 4pcs	Back plate insulation foam

Safety Attentions

Please read the following safety instructions before installation. And ensure that the unit is installed correctly. Please observe all instruction in order to avoid any injury or damage to equipment or property.

The following symbols indicate potential levels of caution.		The following symbols indicate compliance which must be observed.	
 Warning	Situations with a risk or death or serious injure		Not allowed or Stop
 Warning	Situations with a risk of injury or equipment damage.	 	Must follow or obliged
	Don't install in the place of flammable gas leakage, the gathering of leakage gas will cause fire accident.		After installation, non-professional person move the product privately will cause damage to the equipment.
	Please don't block the indoor outlet and return air inlet so as to avoid fan abnormalities.		Be sure to turn off the power before maintenance or contact the electrical parts
	Please don't operate the machine with wet hands, especially plugs and electrical parts.		Must use three-phase power socket. Improper ground wire connection may cause electric shock.
	Don't remove motor and circuit board to avoid electric leakage.		
	This product is 120V ~ 60Hz power supply and three-pin plug. Please use suitable power supply.		Please use a clean soft cloth to wipe the machine to avoid scratch
	This product is common residential product. If used in special circumstances, please consult our technical staff first.		For daily turn off, please use the touch screen controller. If not at home for a long time, please cut off the power to save energy.
	Please follow the maintenance instructions in this manual: clean the return air filter and total heat exchanger regularly; replace primary filter and HEPA filter regularly		Please install the product in environment where humidity smaller than 85%; do not introduce fresh air in poor environment area. Fresh air outlet should be away from the kitchen ventilator, garbage dumps, pollution discharge outlet, air conditioning outdoor units.

Product Introductions

Working Principle and Functions

The wall mounted energy recovery ventilator, which integrates air purification and energy recover function. This product is made of supply fan, exhaust fan, heat exchanger, primary filter, medium filter, activated carbon filter and HEPA filter at OA side, primary filter at RA side. It has functions as below:

1, Fresh air purification: after the outdoor air driven by supply fan and go through the primary filter, it will have energy exchange with the RA in the heat exchanger; and after the fresh air further filtered by the HEPA filter, then sent to indoor; meanwhile, the EA fan will exhaust the polluted air to the outdoor, so to improve the indoor air quality.

2, Energy recover: Usually the temperature difference between indoor and outdoor is very large. When the indoor is under the comfortable temperature and humidity, it will increase the burden of air conditioning system if we send the fresh air to indoor directly after filtering. In order to avoid this situation, our ERVs are all equipped with heat exchanger, which can recover the energy of EA and then recycle to OA, this function will greatly decrease the loss of energy.

Dimensions (mm)

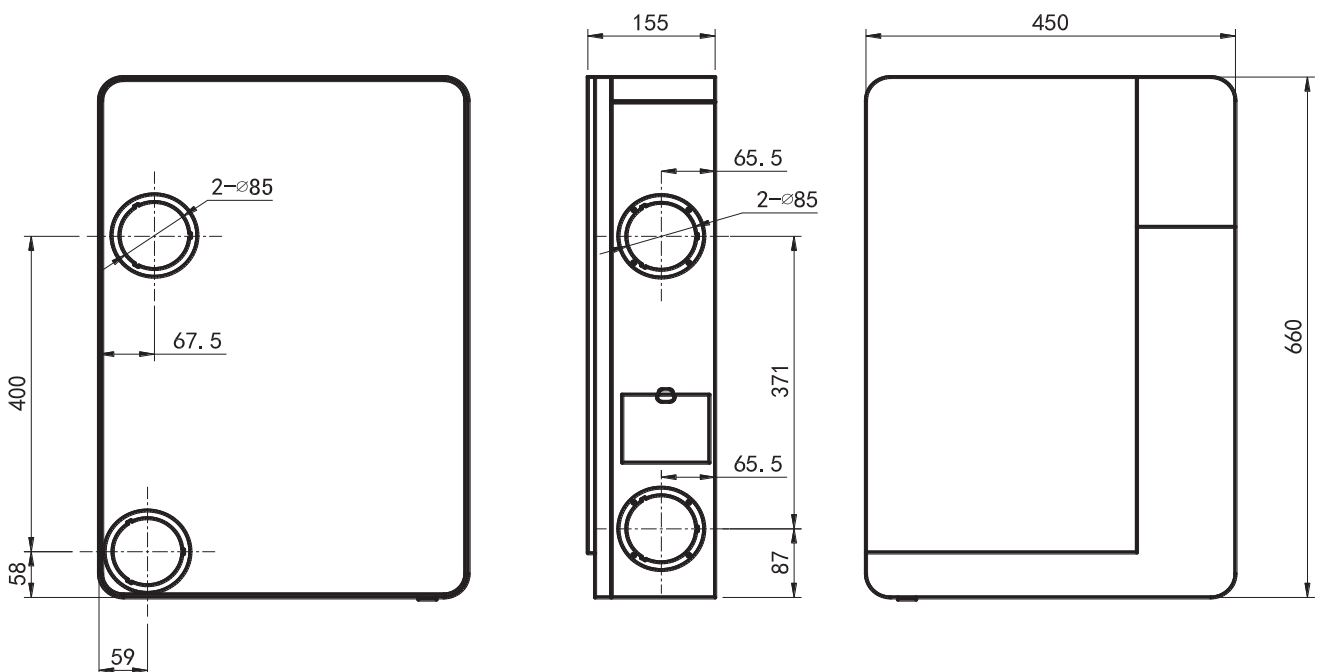

Specification and Operation Instructions

Specification

Model	BEAIR-WM100-CO2 / BEAIR-WM100-Pm2.5		
Airflow (CFM)	88		
Volt (V)	120	IP Class	IPX2
Filtration Capacity (%)	99	Frequency (Hz)	60
Temp. efficiency (%)	82	Noise dB(A)	36
Weight (Kg)	10	Input power(W)	35
Serial number	Refer to the ventilator body	Dimensions (L*W*H)mm	660*450*155

Remarks:The equipment has indoor air purification function, under maximum air supply volume of 88CFM, about 35CFM of indoor circulating air.it's helpful to further clean the indoor air and reduce the PM2.5 level.

User manual of the main interface of display screen

- 1.The upper left corner is the WIFI connection status, devices that are not equipped with WIFI symbol do not display;
2. The upper right corner of the screen is the clock or timing status.
- 3.The upper central part of the screen is the current indoor CO2 concentration / PM2.5 value.
- 4.The lower left side of the screen is the current room temperature and humidity values.
- 5.The lower right side of the screen is the current operation speed of the device.
- 6.At the bottom of the screen are three adjustable buttons.
- 7."Auto" "Manual" "Timing" "Sleep" "PURE-L" "PURE-M" and "PURE-H" are mode indication.

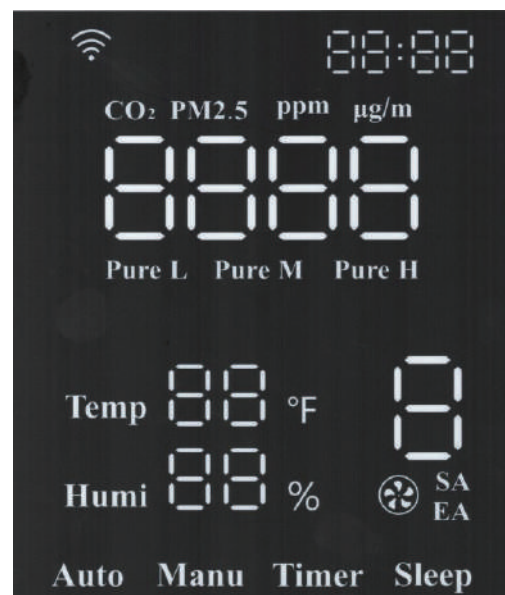

Operation Instructions

Buttons function introduction:

1. Press the button "on/off" to turn on or off the machine;
2. After startup, touch the "Mode" button to switch mode: Auto, Manual, Timer, Sleep, PURE L, PURE M, PURE H.

Remark: when the machine starts, default is "Auto" mode.

3. Under "Manual" mode, touch "Speed" button to select speed 1-8.

Explanation for all modes:

1. Under mode "Auto", it will adjust supply air volume according to indoor CO2/PM2.5 range, corresponding speed as below:

CO2 value	Status	Operational speed
$0 \leq \text{CO}_2 \leq 450$	Excellent	1
$450 < \text{CO}_2 \leq 1000$	Good	3
$1000 < \text{CO}_2 \leq 1500$	Light pollution	5
$1500 < \text{CO}_2 \leq 2000$	Medium pollution	7
> 2000	Serious pollution	8

PM2.5 Value	Status	Operational speed
$0 \leq \text{PM}_{2.5} \leq 35$	Excellent	1
$35 < \text{PM}_{2.5} \leq 75$	Good	2
$75 < \text{PM}_{2.5} \leq 115$	Light pollution	4
$115 < \text{PM}_{2.5} \leq 150$	Medium pollution	5
$150 < \text{PM}_{2.5} \leq 250$	Heavy pollution	7
$\text{PM}_{2.5} > 250$	Serious pollution	8

Remark: To ensure sufficient indoor fresh air supply, the speed will rise automatically after model "Auto" runs for some time, 5-10 minutes later it will recover to previous speed. During this time, the screen shows different speed from above chart.

Operation Instructions

2. Under any mode, the unit will be switched to "Manual" mode when user presses "Speed" button, then press "Speed" again to enter SA/EA fan setting. When "SA" flashes, press "Speed" to set SA fan speed from speed 1-8 ; press "Mode" to switch to "EA" fan setting "EA" flashes, then press "Speed" to set from speed 1-8 . After setting, press "Mode" to save and exit, or the system will automatically save and exit after 15s.
3. "Timer" mode, should be controlled through the remote controller.
4. Under "Sleep" mode, the unit runs in speed 1, after 30s the screen luminance will be half as normal.
5. Mode "PURE L", "PURE M", "PURE H" are to improve indoor air quality rapidly; The purification performance is enhanced progressively for the 3 modes.

Button Combinations

Combinations	Function
Ventilator is on, long press "On/Off + Speed"	1. RESET WIFI 2. Clear connection information
Ventilator is on or off, long press "On/Off + Mode"	Reset to EX-factory default setting
Ventilator is off, long press "On/Off"	Set RS485 address

Operation Instructions

User manual of remote controller

Button function introduction:

1. Press "on" to turn on the ventilator.
2. Press "off" to turn off the ventilator.
3. Press "lock" to turn off the display,
Re-press again to turn on the display.
4. Press "Hour", "Hour" part at the top right corner of the ventilator screen starts twinkling, then press "+" to increase time, press "-" to decrease time, repress "Hour" button to save time and exit.
5. Press "Minute", "Minute" part at the top right corner of the ventilator screen starts twinkling, then press "+" to increase time, press "-" to decrease time, repress "Minute" button to save and exit.

Remark: During twinkling, if no operation in 15s, twinkling ends and save setting automatically.

6. Except for the status of time adjustment and being shut down, press "+" to change speed range from small to large, press "-" to change air speed range from large to small. Switching to "Manual" mode, the SA indicator flashes, press "+" or "-" to adjust the SA speed. After completing the SA speed setting, press "Pure H" switch to the air speed selection of EA (Under this state, the "Pure H" button is equivalent to the "Mode" button), press "+" or "-" to adjust the air speed, after completing the EA speed setting, press "Pure H" button again can exit the speed setting(or automatically exit without action for 15s), the air speed of SA and EA will be saved respectively.
7. The function of "Sleep" button is similar to "Sleep" button on ventilator.
8. The function of "Auto" button is similar to "Auto" button on ventilator.
9. Timer: Press "Timer", timer mode starts, time at the top right corner of the machine screen twinkles. Press "+" to increase time and "-" to decrease time in interval of 30 minutes, the longest timing is 8 hours, default timing is 00:00; Repress "Timer" button to save and exit timer setting, top right corner of the ventilator displays current time again.

Remark: During twinkling, if no operation in 15s, twinkling ends and save setting automatically. After timer setting finished, if repress "Timer" button, top right corner of the display shows remaining time for the timer setting, at this time it is ok to set the timer again. To cancel timer function, set the time to 00:00.

10. The function of "PURE L", "PURE M", "PURE H" is similar to that on the ventilator.

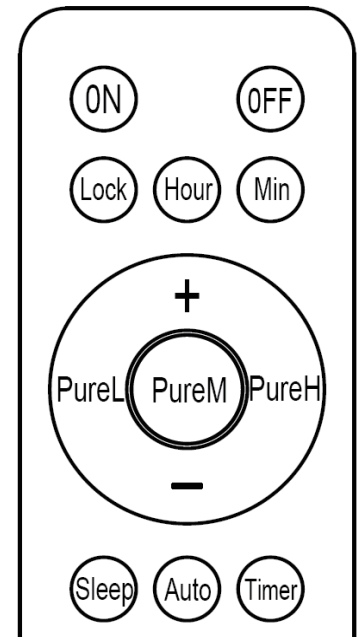

WIFI Function

Installation of "Smart Life"

1. If your phone is Android system, please search and download the APP of "Smart Life" from Google play, while the IOS system can download it from the Apple App Store.



2. Or scan the below QR code to download.



Operation Instruction

1. Registration and log-in

If you do not have an account of "Smart Life", please register and log in by following the processes:

- A. Click "agree" when "User Agreement and Privacy Policy" appear on the interface.
- B. Click "Sign up" button, choose your country and enter your mobile number/email to register, tick "I Agree User Agreement and Privacy Policy", then click "Get Verification Code" button, the phone you're registering will receive a registration verification code;
- C. Enter the verification code, fill in the password, you will get into the homepage of the App or back to the log-in interface to log-in the app by using the account you registered.

2. Adding new device

- A. Make sure your phone is connected to WIFI(2.4G network only, does not support 5G network or any others), click the "+" at the upper right corner in the homepage, entering into network matching.
- B. After entering, long press "On/Off + Speed" button when the ventilator is ON, until the WIFI symbol on the display screen flashes. (Fast flashing refers to WIFI connection, slow flashing refers to hotspot network.)

WIFI Function

C. Choose "Small Home appliance" in the network matching interface, slip downward to find "Ventilation System (Zigbee)", shown as below. After entering into WIFI network matching interface, operate according to the instructions step by step, until network matched successfully, please pay some patience during the network matching.





Ventilation System
(Zigbee)

3. Controlling operation

Entering into the homepage of the App, click the "On/Off" button to control the running status of the ventilator, click "Speed" button to adjust the airflow (Different models correspond to different operations, please operate accordingly based on your purchased model).

4. Modify the device name

- A. Click the symbol  at the upper right corner in the homepage, enter into the homepage menu.
- B. Click the symbol , entering into the setting interface, click "name" button to modify your desired name, then click "Save" button.

5. Device authorization and sharing

- A. The 1st person binding to the device enters into the device menu(as instructed on 4. Modify the device name), then clicks " device sharing"
- B. Enter into the sharing menu, and enter the account number that you want to share, click "Done".
- C. The shared user account appears on the menu if the sharing is successful.

6. Device deletion (unbinding)

- A. Enter into the device menu(as instructed on 4. Modify the device name), then click "device removing".
- B. Click "Removing Binding", followed by " confirm", the device can be unbinding.

7. User information editing

- A. Click "I" on the bottom right corner of the homepage.
- B. Click on the picture above to enter the user information page
- C. After entering into the user information page, you can modify the user information, including avatar, user name (nickname, account number, and security, etc.)

8. Sign out

- A. Click "Me" on the bottom right corner of the homepage, then click "setting" button.
- B. Select "Sign out" at the bottom to logout.

Installation Instructions

Ventilator installation

According to the project site to choose suitable installation location, Air inlet/outlet from back or from the side.

Back installation

1. Choose the suitable location on wall, mark the OA inlet and EA outlet location, also mark the 5 fixing holes of the installation panel on the wall

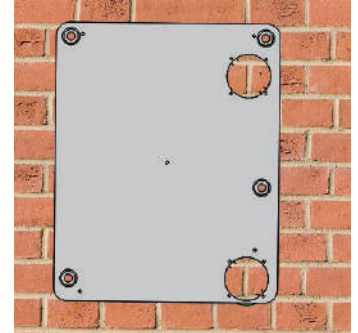

Attention: Ventilator bottom to the floor around 1.5 meters

Ventilator left and right side to the wall not less than 0.3 meter

2. To drill 2 holes on wall for fresh air inlet and exhaust air outlet, recommended size is diameter 100mm, The 2 holes should face downward toward the outside to prevent any rain water ingress. Recommended size for the 5 fixing holes is $\phi 6 \times 70 \text{mm}$, and input the 5 plastic bolt Jacket into the holes

Attention: The OA inlet and EA outlet holes size is according to the Holtop accessories (PVC pipes).

3. Connect the flange to the installation panel by M3X12 bolt and nut



4. According to the wall thickness, cut the suitable length of the PVC pipes, connect the PVC pipes to the OA and EA accessories,
OA side: PVC pipe + Air inlet grille + Rain proof cover + Rubber sealing ring + Tapping screws.
EA side: PVC pipe + Air outlet grille + Rain proof cover + Rubber sealing ring + Tapping screws.

Remark: Holes of $\phi 3 \text{mm}$ need to be drilled in advance before installing the fixing screw.

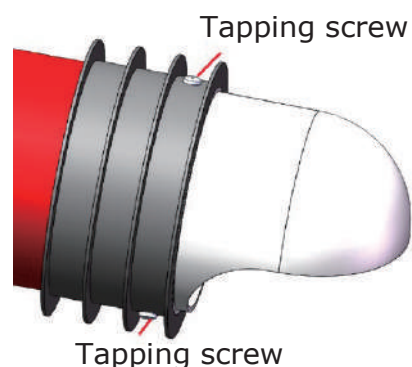
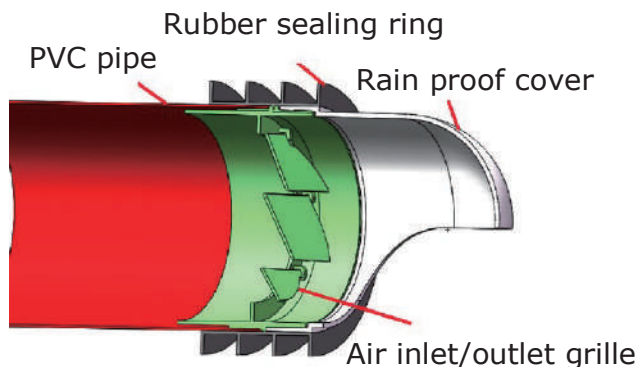

Installation Instructions

5. Put the assembled ducts into the wall, ensure the rain cover towards down, seal the gaps between the duct and the wall.

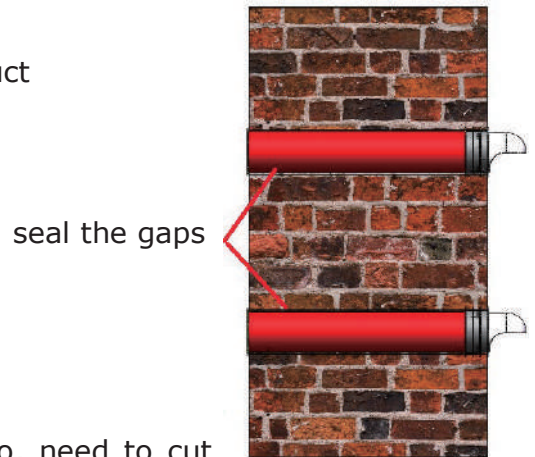

6. Fix the installation panel on wall by the knock-on anchor bolt .

7. The above installation is for "back installation" , so, need to cut the EPS "back cover" at the OA vent as the below picture (DON'T cut the EPS side cover).

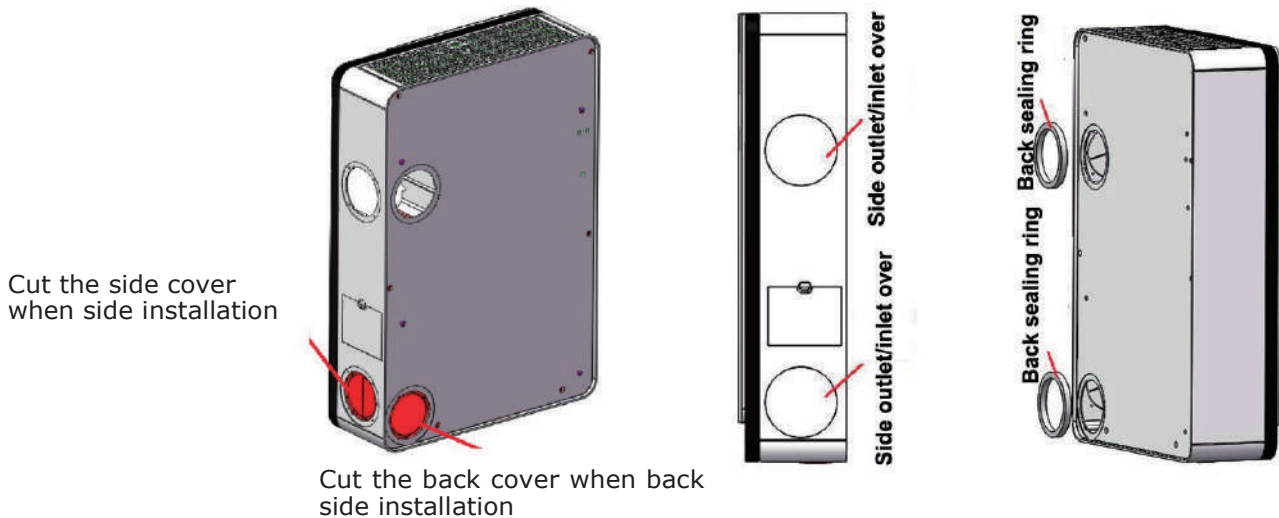

8. Put the 2 round OA and EA Side/Back covers on the side of the ventilator to cover the side air inlet and side outlet. Paste the 10mm seal rings to the back of the air inlet and outlet.

9. Paste the back plate thermal insulated cotton/foam on the back of the ventilator if necessary (around the OA side), it helps avoid the condensing water when the ventilator is used in cold area.

10. Hang the ventilator on the installation panel, user can adjust the 4 pieces M5x18 hanging screws on the back of the ventilator to suit the installation panel.

11. After the installation is completed, power on the ventilator.

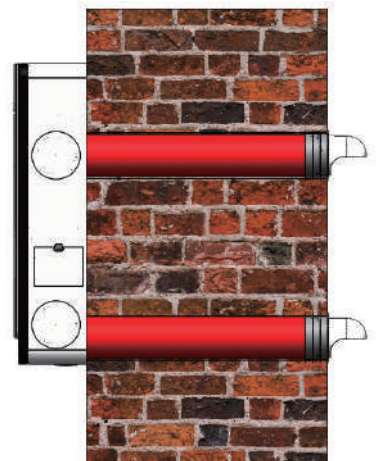

Installation Instructions

Side installation

1. Paste the 3mm side sealing rings on the flanges, connect the flanges to the ventilator side by 8pcs M3x12 bolts and 8pcs M3 nuts. Be careful don't let the nuts drop inside the ventilator during installation.

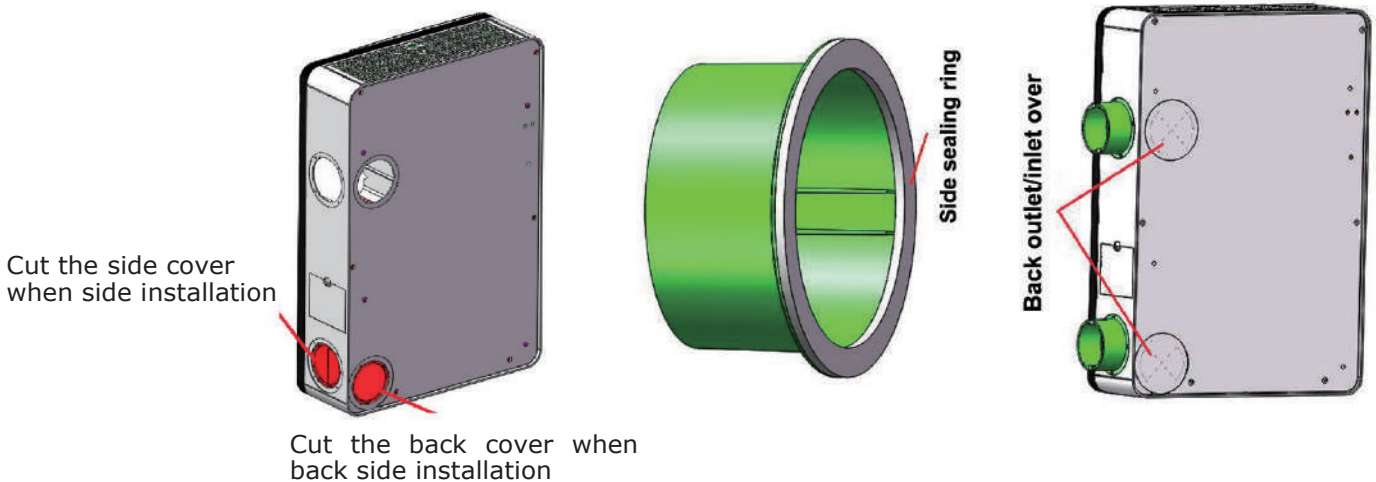

2. This installation is for "side installation" , so, need to cut the EPS "side cover" at the OA vent as the left picture (DON'T cut the EPS back cover), then cover the 2 round OA and EA Side/Back covers to the back of the ventilator

3. Choose the suitable location on wall, mark the 5 fixing holes of the installation panel on the wall, and mark the side OA inlet and EA outlet location of the side wall according to the ventilator dimension

Attention: Ventilator bottom to the floor around 1.5 meters

Ventilator left and right side to the wall not less than 0.3 meter

4. Drill 5 fixing holes $\phi 6 \times 70$ mm (suggesting dimension) on the wall according the installation panel, then fix the installation panel on wall by the 5 Knock-on anchor bolts.

5. Drill 2 holes on wall for fresh air inlet and exhaust air outlet, recommended size is diameter 100mm, The 2 holes should face downward toward the outside to prevent any rain water ingress.

Attention: When drilling the outlet hole on the wall, the opening hole size is only a recommended value. When installing the ventilator by the side way, the ducts should be flexible ducts(prepared by end-users), the hole size on the wall should be finalized by the final used duct diameter.

Installation and Maintenance

6. Hang the ventilator on the installation panel, user can adjust the 4 pieces M5x18 hanging screws on the back of the ventilator to suit the installation panel.
7. According to the wall thickness, cut the suitable length of the flexible pipes, connect the pipes to the OA inlet grille and EA outlet grille, also the rain cover, etc. accessories same like the "back installation". Rain covers towards down.
8. Input the pipes to the wall, seal the gap between wall and the pipes by sealant.
9. Connect the another sides of the pipes to the flanges on side of the ventilator.
10. After the installation is completed, power on the ventilator

OA and RA primary filter maintenance and change

Attention: Before maintenance, the power must be cut off until the device completely stop, avoiding any injury.

OA primary filter and medium filter is at the side of the ventilator while RA primary filter is at the bottom of the ventilator, as showed by the right picture, used to filter the large particle in the air.

- Open the covers according to the marks on the ventilator, take out the primary filters, medium filters.
- OA medium filter is not washable, It is advised to change the filter every 1-2 months.
- OA and RA primary filters are washable, recommended to replace every 3-4 months.

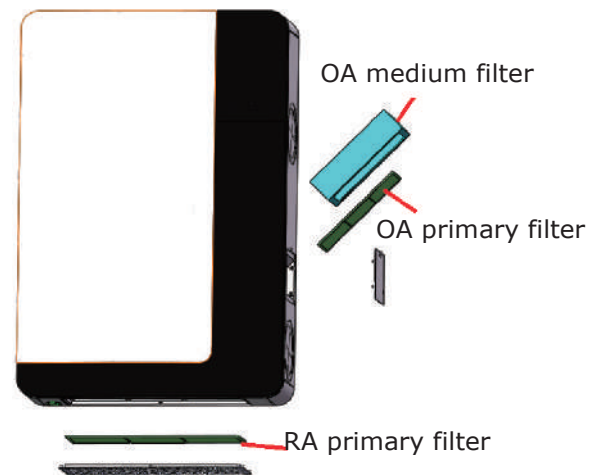

HEPA filter change

HEPA filter is at the top of the ventilator, as showed by the right picture, it is used to filter the small particle that less than 2.5 μ m in the air

- Open the covers according to the marks on the ventilator, take out the HEPA filters and change to be the new one.
- Recommended exchange period of the HEPA filter is 8 to 12 months.

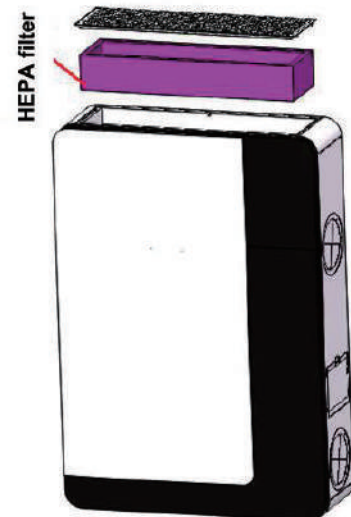

Maintenance

Maintenance of heat exchanger

The plate heat exchanger is installed at the central right of the ventilator, it is the air to air heat exchange device. It's used to separate fresh air and exhaust air, effectively avoid cross-contamination, and ensure that the cleanness of fresh air.

- Take off the ventilator from wall, unscrew the 6 pieces long screws from the back of the ventilator, then to unscrew the access door and take out the plate heat exchanger.
- Clean the dust and dirt on the exchanger by vacuum cleaner
- It is recommended maintain or clean the exchanger every 3 years, for further help can contact manufacturer.

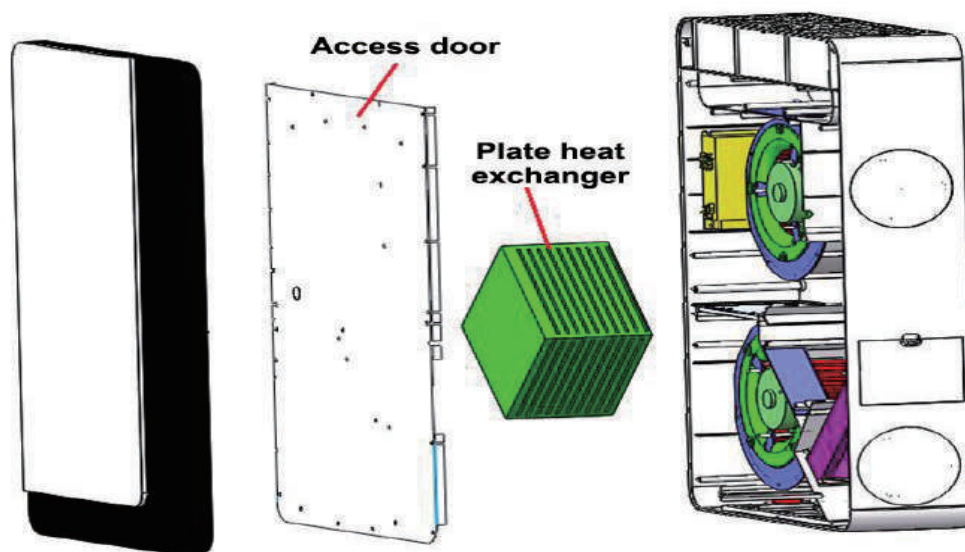

Maintenance of PM2.5/CO2 sensor

In order to prevent the air quality sensor from being blocked, the sensor needs to be cleaned regularly.

- Remove the bottom grid and take off the return air primary filter.

- According to the right picture, use a hair dryer or blower to clean the sensor, When using the hair dryer, do not turn on the hot air.

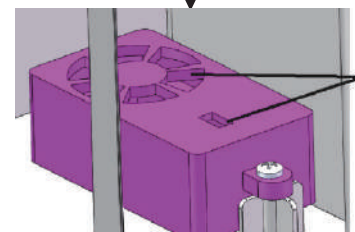
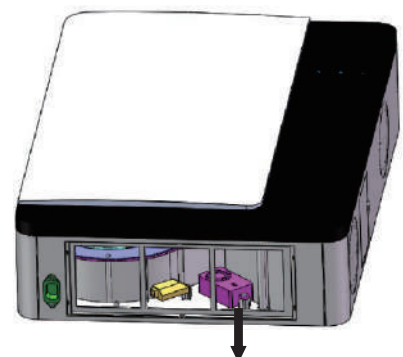

Maintenance of motor and controller

Notice: Not for Non-professional, if any questions please contact manufacturer.

Failure Diagnose

User can make self trouble shooting following below chart in case of any failure.

Phenomenon	Possible reasons	Solutions
The display doesn't start up	<ol style="list-style-type: none"> 1.Loosen or bad contact of power plug 2.Broken of power cable 3.Fault of display 	<ol style="list-style-type: none"> 1.Check if the plug is loosen and reconnect it 2.Replace the power cable of same specification 3.Contact manufacturer for replacement
None or wrong display of temperature, humidity or CO2 values	Sensor short circuit or open circuit	Contact manufacturer for service
The PM2.5/CO2 value display abnormally or doesn't display	<ol style="list-style-type: none"> 1. The PM2.5/CO2 sensor test probe is covered by dust. 2. The sensor is short-circuited or open. 	Following the PM2.5/CO2 sensor maintenance method in the manual to clean up first, if not resolved, contact the manufacturer for service.
Abnormal noise	<ol style="list-style-type: none"> 1.The ducts connecting to machine are not fixed. 2.Foreign matter goes inside the Ventilator. 3.Fault of supply fan or exhaust fan. 	<ol style="list-style-type: none"> 1.Fix the duct 2.Contact manufacturer for repair
Insufficient of fresh air	<ol style="list-style-type: none"> 1.Blockage of foreign matters at air inlet/outlet. 2.Blockage of primary or HEPA filter. 	<ol style="list-style-type: none"> 1.Check and clear the foreign matters 2.Clean or replace the filters
Excess particles at supply air outlet	Overuse of primary and HEPA filters	Replace the filters
No response to the fan speed switch (Code: E0, E1, E3)	<ol style="list-style-type: none"> 1. No feedback from supply and exhaust fan 2. Fault of fans 3. Fault of main controlling board 	<ol style="list-style-type: none"> 1.Contact manufacturer for repair 2.Contact manufacturer for fan replacement

Special declaration

The following situations are not included in the warranty.

1. Obvious man-made sabotage during usage.
2. Usage, maintenance and repair not following the instructions of this manual.
3. Damages caused from any force-major.



www.bremenventilation.com

Email: hello@bremenventilation.com

Add.: 5965 De la Côte-de-Liesse Rd, Saint-Laurent, Quebec H4T 1C3