



Energy Recovery Ventilator

Technical Manual

Model:

BEAIR-100/(fresh-valve)

BEAIR-150/(fresh-valve)

BEAIR-200/(fresh-valve)

BEAIR-300/(fresh-valve)

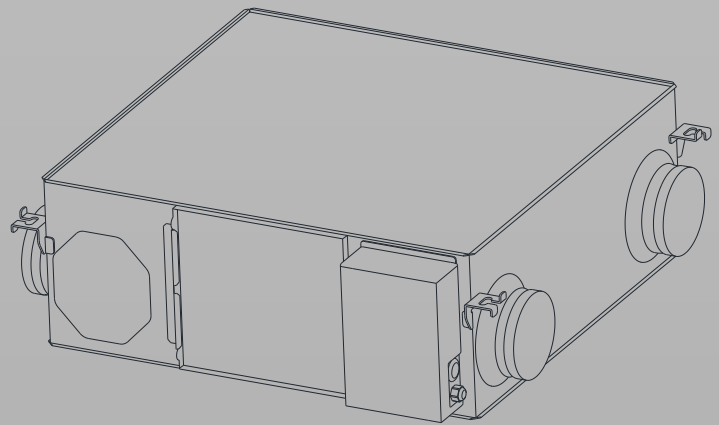

Attention

- ✘ Please read this manual carefully before installing or operating the equipment.
- ✘ Be sure to save this manual for future reference.



Contents















1、 Safety precautions -----	1-2
2、 Unit Description-----	3-5
3、 Installation Considerations-----	6-7
4、 Installation Method -----	7-8
5、 Connecting the ducts -----	9
6、 Electrical Installation -----	10
7、 Precautions for Use-----	11
8、 Commissioning-----	11
9、 Operation Method-----	12-21
10、 Communication protocol-----	22-23
11、 Maintenance-----	24
12、 Failure diagnose-----	25

Packing list:









Pls kindly check after unpacking: one ventilator, one controller and one set of attached data.







1 Safety precautions







The following signs indicate that death or serious injury may be caused by failure to heed the precautions described below.

Safety attentions			
Please read the following safety instructions before installation. And ensure that the unit is installed correctly. Please observe all instruction in order to avoid any injury or damage to equipment or property.			
The following symbols indicate potential levels of caution.			
 Warning	Situations with a risk or death or serious injure.	 Attention	Situations with a risk of injury or equipment/property damage.
The following symbols indicate compliance which must be observed			
	Not allowed or Stop		Must follow  or obliged
 Warning			
	Installation to be carried out by qualified person, End Users must not install, move or re-install this equipment by themselves		An anti-bird net or similar device should be installed to outside vents. Ensure there are no obstructions to or in the ducts
	Installation engineers must follow this manual strictly. Improper action can create a health hazard and reduce efficiency of the unit		Fresh air vent must be far enough away from any flue gas discharge or areas where hazardous vapors are present
	Unit must be installed strictly following this manual and mounted to a weight bearing surface for the weight of the unit		Electric engineering must follow national regulations and the manual, use special cables. Less capacity cables and improper engineering can cause electric shock or fire.
	During maintenance or repair, the unit and circuit breaker must be switched off. Otherwise electric shock could occur.		Ground wire cannot be connected to gas pipe, water pipe, lighting rod or telephone line etc. Incorrect grounding can cause electric shock.

Safety precautions

 Attention			
	Power cable and wires must be installed by a qualified electrical engineer. Improper connection can cause over heating. Fire and loss of efficiency.		To avoid condensation, insulation should be fitted to fresh air ducts. Other ducting may also require insulation depending on dew point conditions.
	Insulation between the metal ducting and wall penetration must be installed if the ducting penetrates metal wall cladding, to avoid risk of electric shock or current leakage.		The cover of wiring box must be pressed down and closed to avoid dust and dirt entering. Excess dust and dirt can cause overheating of terminals and result in fire or electric shock.
	Use only approved installation hardware and accessories. Failure to observe can result in fire risk, electric shock and equipment failure		Where the unit is positioned, at high level in a hot humid situation. Please ensure sufficient ventilation is available
	The outdoor ducts must be installed facing downwards to avoid rain water entering. Improper installation can cause water leakage.		Correctly sized MCB must be fitted to the unit suitable earth leakage protection should also be installed to avoid risk of electric shock or fire.

 Attention			
	Do not install the unit in an extremely humid conditions, as it may result in electric shock and pose a fire risk.		Do not use the units as the primary kitchen extract grease and fatty deposits can block the heat exchanger, filter and pose a fire risk.
	Don not install the unit in areas there any poisonous or caustic gases are present.		Do not install the unit near open flame as it may result in over heating and pose a fire risk
	Acidic or alkali environments can cause poisoning or a fire		Rated supply voltage must be maintained, otherwise this may cause fire.

 Warning			
	This appliance can be used by children aged from 8 years and above and persons with reduced physical, sensory or mental capabilities or lack of experience and knowledge if they have been given supervision or instruction concerning use of the appliance in a safe way and understand the hazards involved.		
	Children shall not play with the appliance.		Cleaning and user maintenance shall not be made by children without supervision.
	Means for disconnection must be incorporated in the fixed wiring in accordance with the wiring rules.		Prior to cleaning or other maintenance, the appliance must be disconnected from the supply mains.

2 Unit Description

2.1 Principle and function

Energy Recovery ventilator is a kind of ventilator equipment for air energy recovery. It is composed of supply air fan, exhaust fan, total heat exchanger, primary filter of original air, primary filter of return air, etc.

Energy Recovery ventilator function: the purified fresh air is continuously transported to the room through the air supply outlet, and the indoor dirty air is discharged at the same time, so as to improve the indoor air quality.

Energy recovery function: The total heat exchanger is used to effectively recover the temperature and humidity energy in the exhaust air and return it to the air supply, so as to reduce energy consumption.

2.2 Instruction

Item	Content	
Type	Ceiling Mounted	
Ventilator	Speed	10
	Structure	Galvanized sheet shell + Integrated EPS foam structure + internal insulation
	Heat Exchanger	Integrated resin frame + efficient paper core
	Fan	DC Fan
	Controller	Machine body control + Remote Intelligent controller + WIFI (optional)
	Bypass	100% automatic control
	Filter	G4
Power	120V~ 60Hz	
Application	Temperature: -4~113°F Humidity: Below85% R H	

2.3 Dimensions

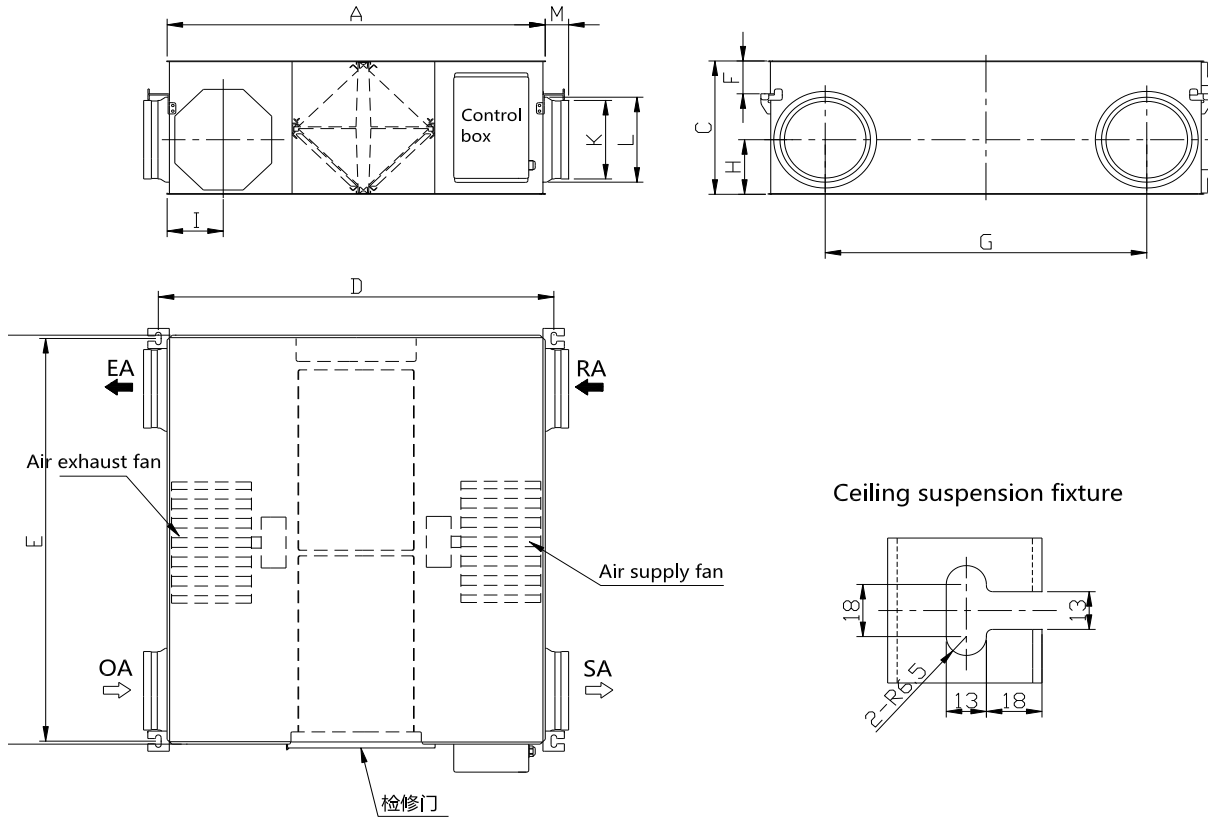

Nominal diameter	
Model	Diameter
BEAIR-100/(fresh-valve)	Φ100
BEAIR-150/(fresh-valve)	Φ150
BEAIR-200/(fresh-valve)	Φ150
BEAIR-300/(fresh-valve)	Φ200

Model	Dimensions			Ceiling suspension fixture pitch			Duct pitch			Duct connecting flange			Weight (Kg)
	A	B	C	D	E	F	G	H	I	K	L	M	
BEAIR-100/(fresh-valve)	780	610	289	819	594	78	450	95	116	95	110	53	20
BEAIR-150/(fresh-valve)	780	735	289	819	719	78	526	95	116	144	160	58	23
BEAIR-200/(fresh-valve)	884	874	331	922	958	81	650	135	132	144	160	58	30
BEAIR-300/(fresh-valve)	884	1016	331	922	1000	81	750	135	132	195	211	61	33

2.4 Performance parameters

Model:BEAIR-100/(fresh-valve)
 0.2in.WC(50PA) 106CFM Volts:120V Hz:60Hz single phase
 0.4in.WC(100PA) 89CFM Watts:83W

Mode	Supply temperature		Net airflow		Power (W)	Sensible recovery efficiency	Adjusted sensible recovery efficiency	Net moisture transfer
	°F	°C	L/s	CFM				
Heating Tests	32	0	13.9	29.4	21	81.4	86.4	34
	32	0	27.7	58.8	65	70.5	78	21
	32	0	41.6	88.2	83	68.5	74.5	37
Cooling tests						Adjusted Toal recovery efficiency %		
	95	35	27.7	58.8	/	/		
	95	35	41.6	88.2	83	53.6		

Model:BEAIR-150/(fresh-valve)
 0.2in.WC(50PA) 162CFM Volts:120V Hz:60Hz single phase
 0.4in.WC(100PA) 147CFM Watts:93W

Mode	Supply temperature		Net airflow		Power (W)	Sensible recovery efficiency	Adjusted sensible recovery efficiency	Net moisture transfer
	°F	°C	L/s	CFM				
Heating Tests	32	0	27.7	58.8	17	84.3	85.4	29
	32	0	41.6	88.2	30	77.4	79.8	21
	32	0	69.4	147.1	93	71.7	74.7	33
Cooling tests						Adjusted Toal recovery efficiency %		
	95	35	41.6	88.2	/	/		
	95	35	69.4	147.1	93	52.1		

Model:BEAIR-200/(fresh-valve)
 0.2in.WC(50PA) 229CFM Volts:120V Hz:60Hz single phase
 0.4in.WC(100PA) 206CFM Watts:129W

Mode	Supply temperature		Net airflow		Power (W)	Sensible recovery efficiency	Adjusted sensible recovery efficiency	Net moisture transfer
	°F	°C	L/s	CFM				
Heating Tests	32	0	27.7	58.8	23	87.6	89.2	50
	32	0	55.5	117.6	47	78.9	80.5	45
	32	0	97.1	205.9	129	74.8	77.4	45
Cooling tests						Adjusted Toal recovery efficiency %		
	95	35	55.5	117.6	/	/		
	95	35	97.1	205.9	129	59.2		

Model:BEAIR-300/(fresh-valve)
 0.2in.WC(50PA) 318CFM Volts:120V Hz:60Hz single phase
 0.4in.WC(100PA) 294CFM Watts:180W

Mode	Supply temperature		Net airflow		Power (W)	Sensible recovery efficiency	Adjusted sensible recovery efficiency	Net moisture transfer
	°F	°C	L/s	CFM				
Heating Tests	32	0	55.5	117.6	31	82.6	83.7	36.5
	32	0	97.1	205.9	73	76.5	78	45.8
	32	0	138.7	294.1	180	71.2	73.5	41.7
Cooling tests						Adjusted Toal recovery efficiency %		
	95	35	97.1	205.9	/	/		
	95	35	138.7	294.1	180	50.1		

3 Installation Considerations

3.1 Protect the unit to avoid dust or other obstructions entering the unit and accessories during installation, or whilst in storage on site. Service ports should be installed to allow access for filter maintenance.

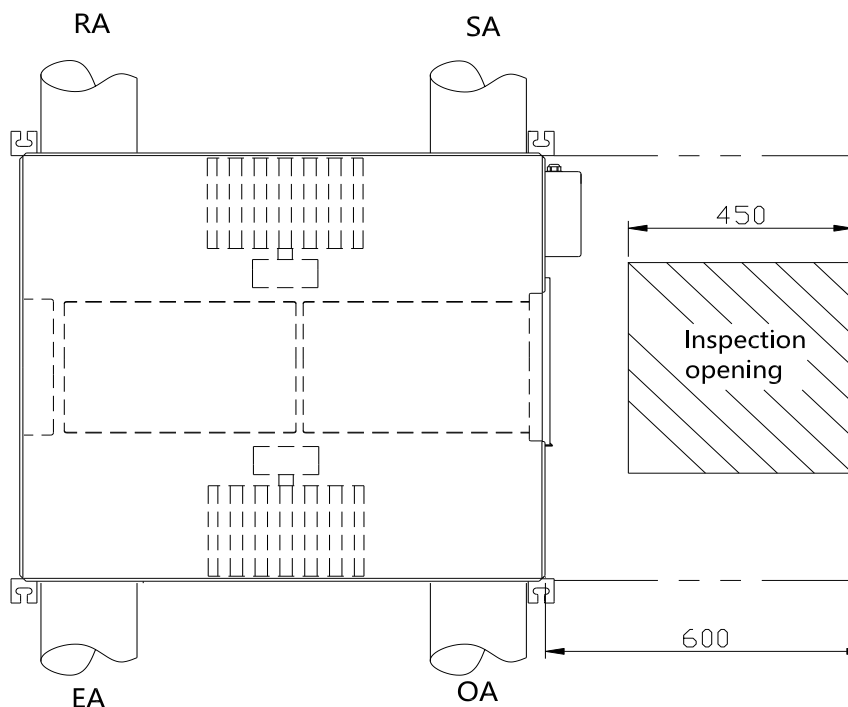

3.2 Be sure the ceiling height is no less than the Figures in above table B column.

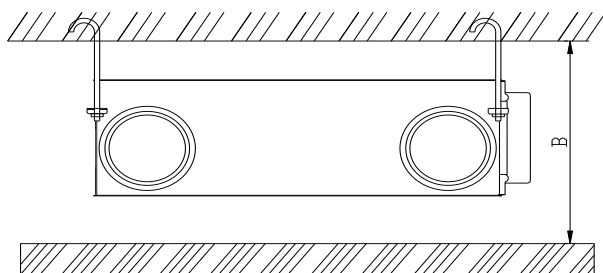

Model	Inner ceiling height B
BEAIR-100/(fresh-valve)	340
BEAIR-150/(fresh-valve)	340
BEAIR-200/(fresh-valve)	390
BEAIR-300/(fresh-valve)	390

3.3 Unit must not be installed close to boiler flues.

3.4 Following phenomenon should be avoided in the ducting installation.

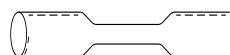
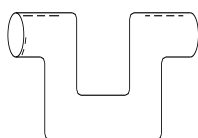
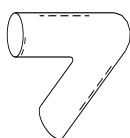

Severe bends

Multiple direction changes

Multiple reducers/ crimped duct

3.5 Excessive use of flex-duct and long flex-duct runs should be avoided.

3.6 Fire dampers must be fitted as per national and local fire regulations.

3.7 Unit must not be exposed to ambient temperature above 104°F and should not face an open fire.

Installation Considerations AND Installation Method

3.8 Take action to avoid dew and frost.

As shown by drawing below, unit will produce dew or frost when saturation curve is formed from A to C. Use pre-heater to ensure conditions are kept to right of the curve (B to B'), to move C to C) to prevent condensation or frost formation.

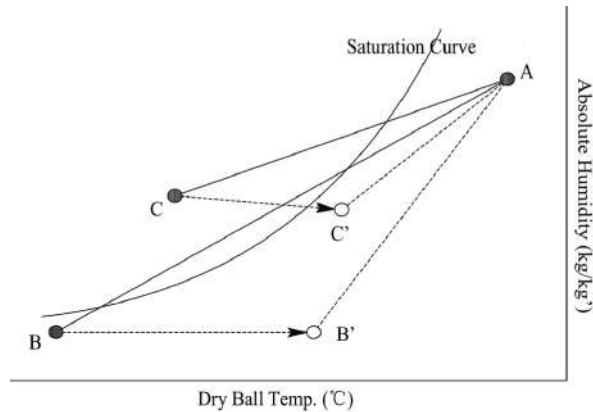

3.9 To avoid the outdoor exhaust air cycling back to indoor, the distance between the two vents installed on the outside wall should be over 1000mm.

3.10 If heater is equipped to the unit, operation of heater should be synchronous with the unit, so that the heater starts to work only when unit starts.

3.11 Duct muffler may be considered if user wants indoor noise to be minimized.

4 Installation method

4.1 Preparing the anchor bolts

Mount the washers (outer diameter of >21 mm for M10, >24mm for M12) and nuts onto the pre-recessed anchor bolts (M10 or M12), as shown in the figure below.

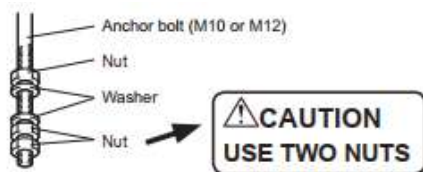

When using (customer-prepared) vibration isolation rubber, there is a possibility of this causing a decrease in strength, so we recommend the following type of construction.

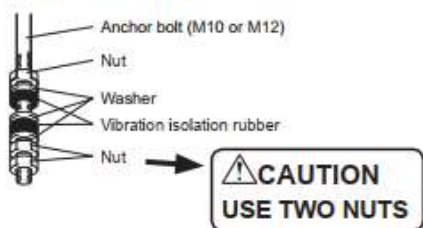

4.2 Installation equipment

- 1) Hang the ceiling suspension fixtures on the anchor bolts and adjust in such a way that equipment is level.
- 2) Tighten up securely using double nuts.

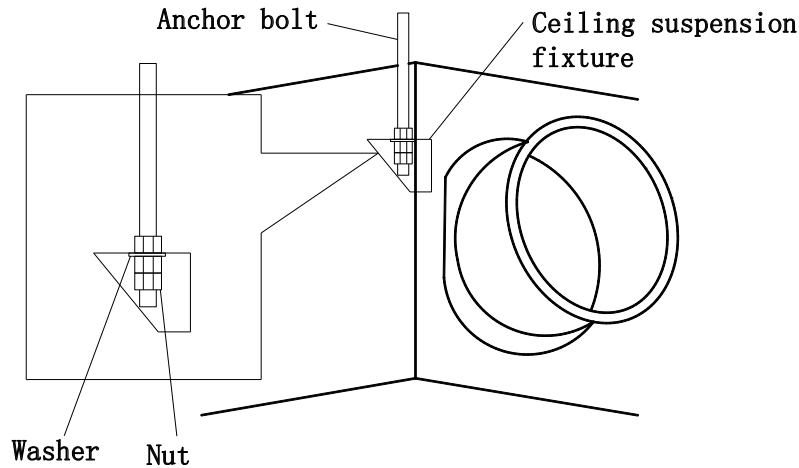

4.3 Physical Installation

- 1). Installer to prepare suitable threaded hangers with adjustable nuts and gaskets.
- 2). Install as shown by the image above. Installation must be level and securely fastened.
- 3). Failure to observe proper fixing could result in injury, equipment damage and excessive vibration.

Uneven installation will also effect damper operation.

- 4). Notes for reverse installation of the unit, Reverse labeling shows the unit is upside down.

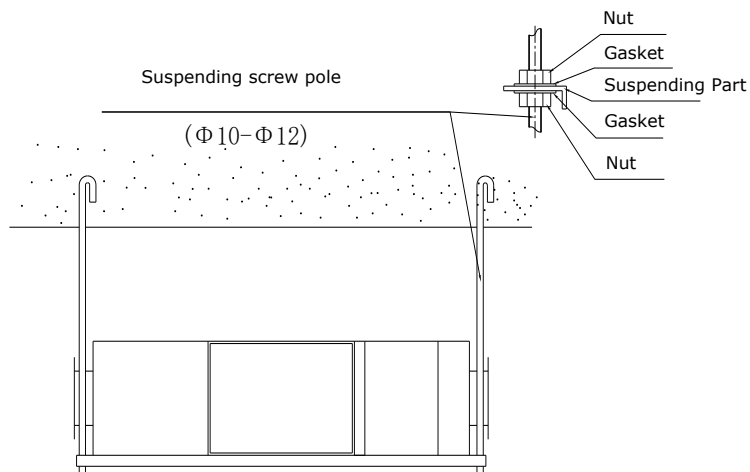

5 Connecting the ducts

5.1 Fasten the duct securely to duct connecting flange, and aluminium tape (field supply) around the joints so that there is no air leakage.

5.2 Suspend the ducts from the ceiling so that their weight will not be applied to the unit.

5.3 The two outdoor vents should face downward toward the outside to prevent any rain water ingress.

(angle 1/100 1/50).

5.4 Insulation must be with the two ducts outside to prevent condensation.

Material: glass cotton, Thickness: 25mm

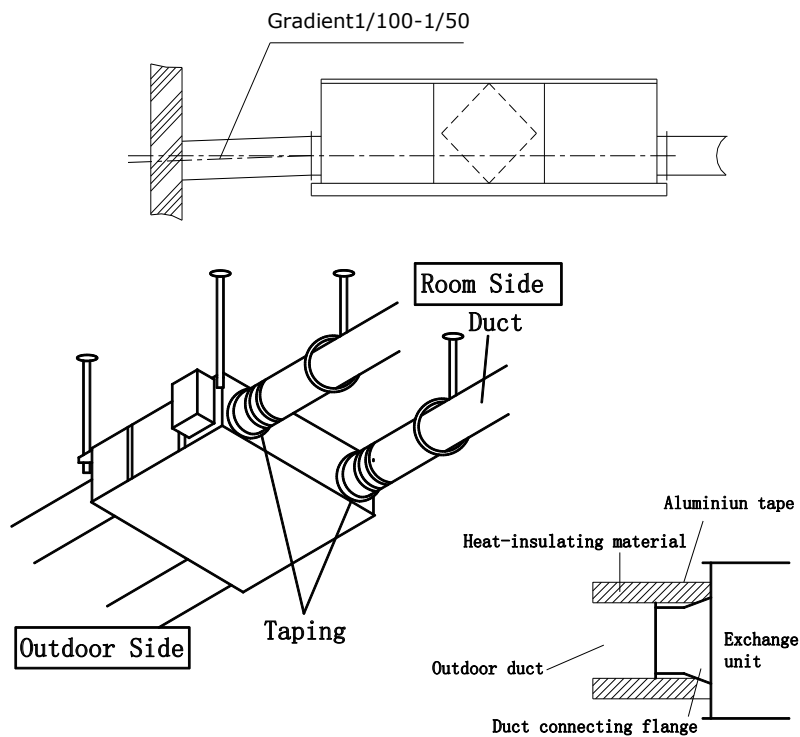

Standard installation examples

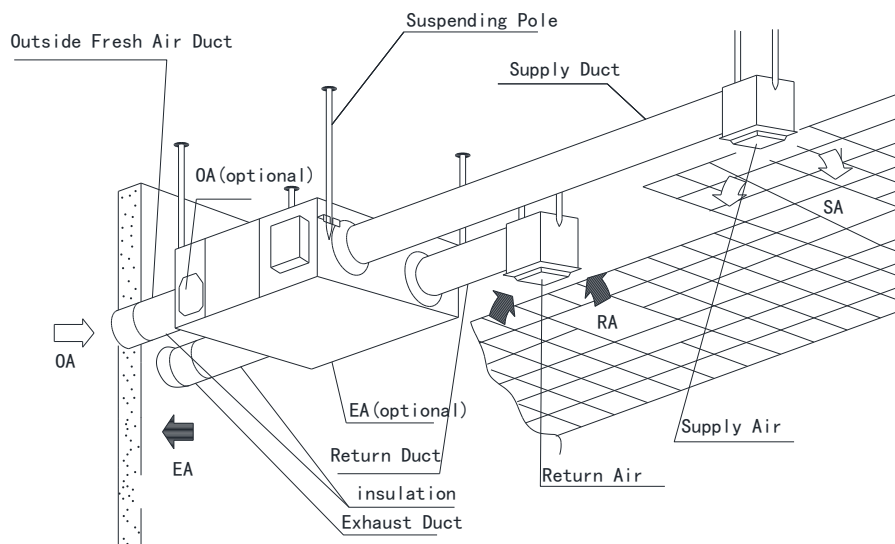

6 Electrical Installation



Warning

Power must be isolated during installation and before maintenance to avoid injury by electric shock. The specifications of cables must strictly match the requirements, otherwise it may cause performance failure and danger of electric shock or fire.

Power supply is AC120V/60HZ/1 Phase. The product has been connected to the power cord, the user needs to plug the power plug into the safety socket .

Model	Spec. of power supply cable	Spec. of normal controller cable
BEAIR-100/(fresh-valve) to BEAIR-300/(fresh-valve)	3 core 16AWG	4 core 20AWG



Warning

We do not accept any liability for any problems caused by the user's self and non-authorized re-engineering to the electrical and control systems.



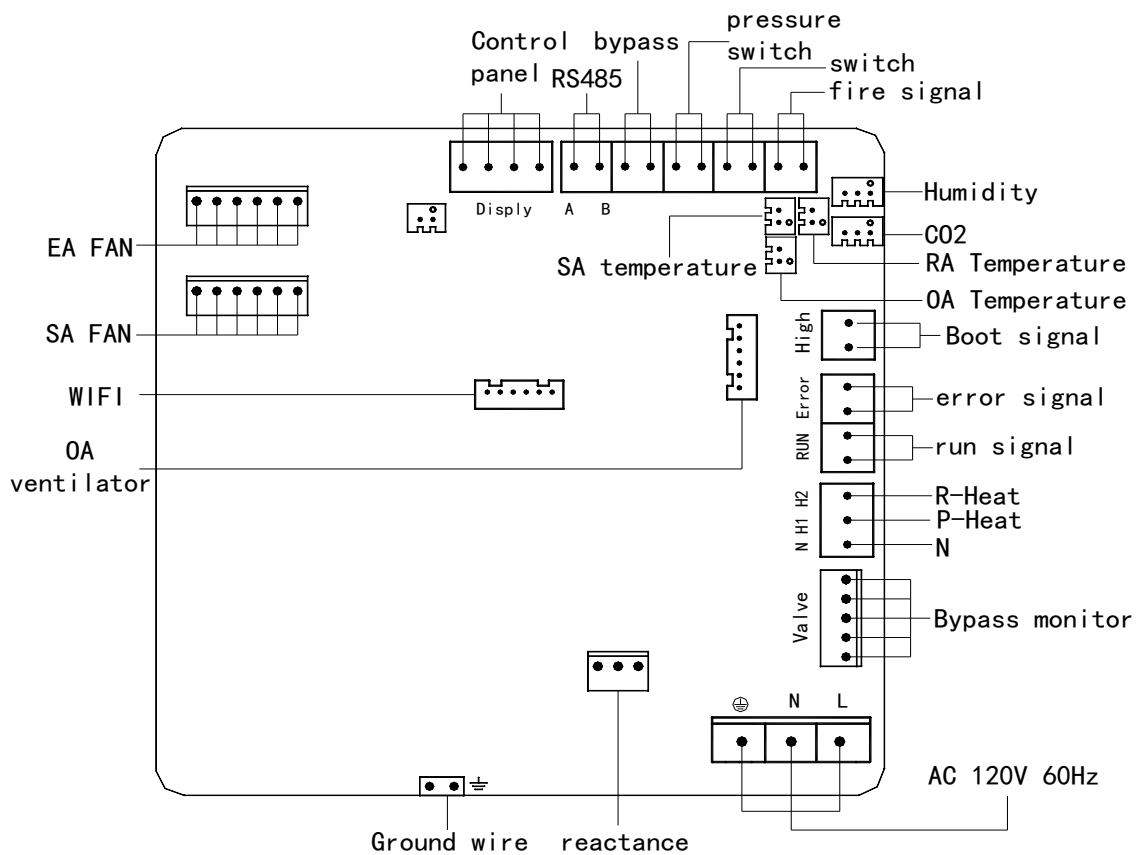









Wiring Diagrams



Model	Power supply	Panel type
BEAIR-100/(fresh-valve) to BEAIR-300/(fresh-valve)	120V~60Hz	HDK-CK23C2/HDK-CK23C1(optional)

Precautions for Use and Commissioning

7 Precautions for Use

 Warning			
	Loose or incorrect wiring connection can cause explosion or fire when the unit starts to work. Use only rated power voltage.		Don't put fingers or objects into vents of fresh air or exhaust air supply. Injury may be caused by the rotation of the impeller.
	Don't install, move or re-install the unit by yourself. Improper action may cause unit instability, electric shock or fire.		Don't change, disassemble or repair the unit by yourself. Improper action may cause electric shock or fire.
	Running the unit continuously in an abnormal status may cause failure, electric shock or fire.		Switch off the power and breaker when you clean the exchanger.
 Attention			
	Don't site intake supply vent in hot and humid conditions, as it may cause failure, current leakage or fire.		Don't put any burner directly facing the fresh air discharge, otherwise it may cause an insufficient burning.
	Isolate power during extended off periods. Isolate power and take care when cleaning unit. (Risk of electric shock)		Observe guidelines and regulations relating to incomplete combustion when use is associated with fuel burning appliances.
	Clean the filter regularly. A blocked filter may result in poor indoor air quality.		

8 Commissioning

8.1 Check the wiring after the installation works are completed, and there must be commissioning.

8.2 Turn on the power supply, and carry out the commissioning and operation according to controller instructions. Check the working conditions of the blower, exhaust fan and bypass. The motor will stop running for more than 10 seconds when the bypass valve of the ventilator is operating.

8.3 When abnormalities occur in commissioning, it can be thought that the connection is wrong. To prevent electric shock, please turn off the special circuit breaker immediately and reconnect the wire correctly.

9 Operation Method (HDK-CK23C2)

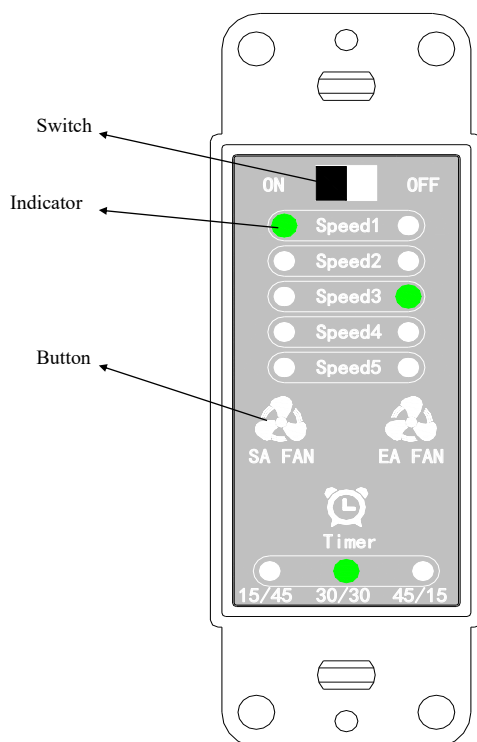

Function Instructions

No.	Function	Instructions
1	On/off button	ON-turn on / OFF-turn off
2	SA Fan Control	Supply Air Fan: 5 speeds for optional
3	EA Fan Control	Supply Air Fan: 5 speeds for optional
4	SA speeds indication	indicator lamp indicate the set speed
5	EA speeds indication	indicator lamp indicate the set speed
6	Constant operation	The unit works continuously at the set speed
7	Intermittent operation(15mins)	The unit works at the set speed for 15mins,then stop for 45mins, and continue the cycle according to this process
8	Intermittent operation(30mins)	The unit works at the set speed for 30mins,then stop for 30mins, and continue the cycle according to this process
9	Intermittent operation(45mins)	The unit works at the set speed for 45mins,then stop for 15mins, and continue the cycle according to this process
10	Controller communication failure	All the 13 indicator lamps flashing
11	Failure Display 1	SA FA failure, all the SA Fan indicator lamps flashing
12	Failure Display 2	SA FA failure, all the SA Fan indicator lamps flashing

Operation Instructions

1).ON/OFF: ON: turn on the units; OFF: turn off the units.

2).Set Fan Speeds: Press “SA FAN” to set the speed of SA Fan; Press “EA FAN” to set the speed of EA Fan.

3).Set intermittent operation(15mins): Press “Timer”, while “15/45” indicator lamp is on, the unit works at the set speed for 15mins,then stop for 45mins,and continue the cycle according to this process.

4).Set intermittent operation(30mins): Press “Timer” while “30/30” indicator lamp is on, the unit works at the set speed for 30mins, then stop for 30mins, and continue the cycle according to this process.

5).Set intermittent operation(45mins): Press “Timer”while “45/15” indicator lamp is on, the unit works at the set speed for 45mins, then stop 15mins, and continue the cycle according to this process.

6).Constant operation: While “15/45”、“30/30”、“45/15”indicator lamps all is off(can set by press “Timer”), the unit works continuously at the set speed

9、 Controller Instructions (HDK-CK23C1)

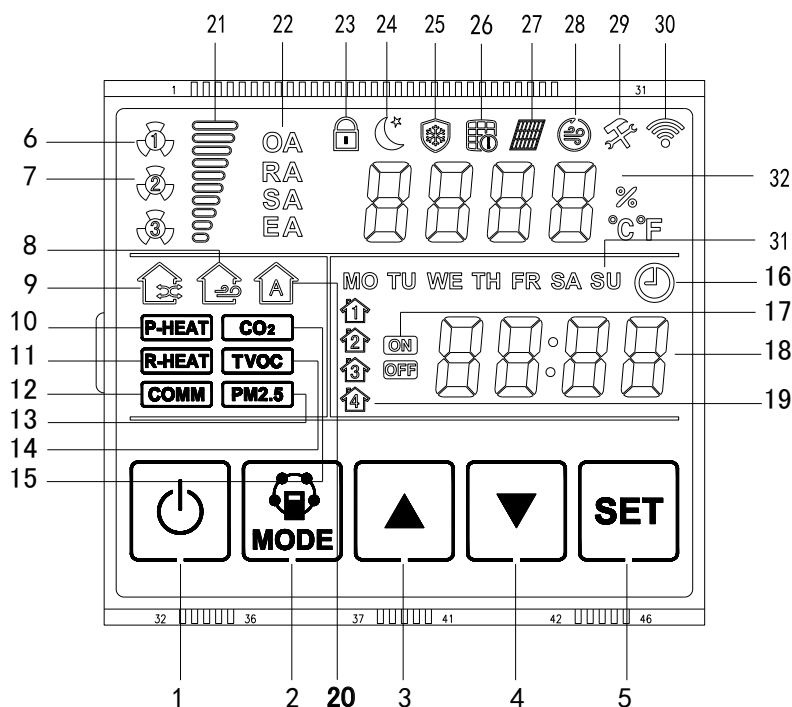

Display Screen and Buttons

No.	Name
1	ON/OFF Button
2	MODE Button
3	UP Button
4	DOWN Button
5	SET Button
6	Supply Air Fan on/off
7	Exhaust Air Fan on/off
8	Bypass mode on/off
9	Heat exchange mode on/off
10	Pre heating
11	Heating
12	Communication
13	PM2.5
14	TOVC
15	CO2
16	Clock
17	Timed power on/off
18	Time
19	Time period
20	Automatic Mode
21	Fan Speed
22	Temperature Type
23	Lock
24	Sleep mode
25	Defrost
26	Filter alarm
27	Heat exchanger alarm
28	High Speed
29	Error
30	WIFI
31	Week
32	Temperature and humidity

Operation Instructions





1).On/off button: Turn on or turn off the equipment.

When it is turned on, the back light of the display screen will be on, and it will be off if there is no operation within 30 seconds ;when the back light is off under the power on state, press any button and it will be on again. When it is turned off, the display screen goes out, after the device is turned on again, it will keep the same running mode as before shutdown.

2).Time setting function

Turn on the equipment, in any interface, long press the SET button in 3 seconds to start time setting, at this time "hour" flashes, short press the up and down buttons to set the hours, after hours setting one, short press the SET button again to enter "minute" and "week" setting, under the same way to set "minute" and "week", then short press Mode button or no operation in 15 seconds to exit the setting.



3). Screen lock setting: The controller screen is locked

When it is turned on, the back light  of the display screen will be on, long press the On/Off button in 5 seconds to lock screen, then icon  is displayed, no operation can be performed in the  screen-locked state, long press On/Off button for more than 5 seconds to unlock the device, then icon  is disappeared.



4)、 Operation Mode:

When it is turned on, the screen display is heat exchange mode, user can press the MODE button to switch the operating mode of the device. The sequence is heat exchange mode, bypass mode, automatic mode (four periods mode), and sleep mode, is switched cyclically.

① Heat Exchange Mode:

In the heat exchange mode, the speed of supply air and exhaust air display alternately, the return air temperature (RA) display, the heat exchange display and time display. Press the up and down button to adjust the speed of supply air, the icon  is displayed. Short press the SET button to switch the speed setting of exhaust air, the icon  is displayed, press the up and down buttons to adjust the speed of exhaust air, and short press the "Mode" button to exit after the setting is completed (or automatically exit after 15 seconds).

② Bypass mode

In the bypass mode, the bypass is turned on, the speed of supply air and exhaust air display alternately, the return air temperature (RA) display, the bypass display and time display. Press the up and down buttons to adjust the speed of supply air, the icon  is displayed. Short press the SET button to switch the speed setting of exhaust air, the icon  is displayed, press the up and down button to adjust the speed of exhaust air, and short press the "Mode" button to exit after the setting is completed (or automatically exit after 15 seconds). When the bypass mode is switched to another mode, the bypass need to be off first.

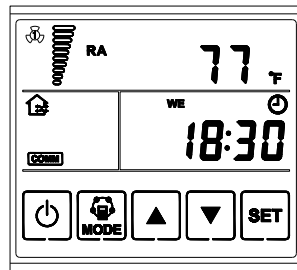

Heat Exchanger Mode

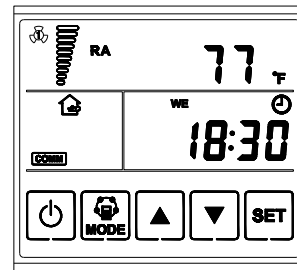

Bypass Mode

③ Automatic mode (Four period timing)

In the automatic mode, enter the regular running status of the four period timing, the speed of supply air and exhaust air display alternately, the return air temperature (RA) display, the automatic mode display, the time period display and timing display. If the automatic bypass is turned on, the device runs the heat exchange mode when it does not meet the auto-bypass mode opening condition, and the automatic mode icon and the heat exchange mode icon are displayed at the same time. When the auto-bypass mode opening condition is reached, the device runs the bypass mode, the automatic mode icon and the bypass mode icon are displayed at the same time. If the automatic bypass is not turned on, the device runs heat exchange mode.

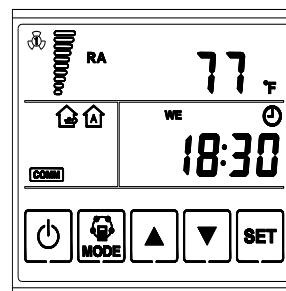
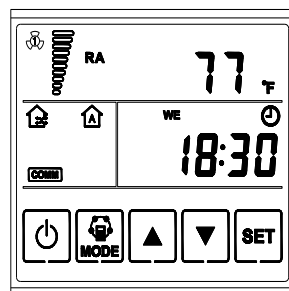

Automatic Mode

Note: There are two status, one is heat exchanger, another is Auto Bypass on.

④ Sleep Mode:

In the sleep mode, the supply air fan and exhaust air fan are running in speed 1, and the screen becomes darker and standby after 30s. When the automatic bypass is not turned on (or the bypass mode opening conditions are not reached), the icon of the sleep mode and the heat exchange mode are long bright. When the automatic bypass is turned on (or the bypass mode opening conditions are reached), the sleep mode icon and the bypass mode icon are long bright. In the sleep mode, press any button could activate the display panel.

Note: When the display panel interface activates is light, the speed of supply air and exhaust air are displayed alternately, the return air temperature (RA) display, and time display.

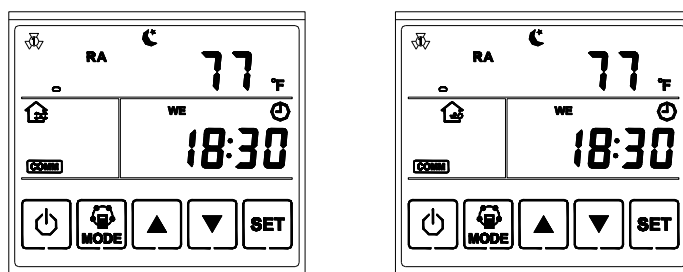

Sleep Mode

Note: There are two status, one is heat exchanger, another is the automatic Bypass on.



5)、Automatic Bypass

When the automatic bypass is turned on, when the OA temperature is detected higher than or equal to X (X is the set temperature value), and the OA temperature is within the $X \pm Y$ range (Y is the temperature deviation value), the bypass is opened automatically. For example, if the X is set to 20 and Y is set to 5, then when the outdoor environment temperature is 15-25 degrees Celsius, the bypass will be opened automatically, and the bypass is turned off automatically under other operating conditions. (Note: X and Y can be set in the parameter item)





6). Four period timing setting

24 hours a day are divided into four time nodes. At each time node, user can set the speed of the device, the device will run until the next time node according to the set speed. This mode can set the speed at each time period from Monday to Sunday, and the speed before the first time node runs according to the fourth time node.

In the automatic mode, short press the SET button to start the four period time settings. First of all, the “week” flash, after short press Up and Down buttons to set the week, then short press the SET button to switch to the hour setting of the first period corresponding to the current week. After short press the Up and Down buttons to set the hour and then short press the SET button again to switch to the minute setting.

After short press the Up and Down buttons for setting for minutes and then short press the SET button again to switch to the setting of the speed of supply air, the icon  flash, After short press the Up and Down buttons for setting for speed of supply air and then short press the SET button again to switch to the setting of the speed of exhaust air, the icon  flash. Short press the Up and Down buttons again to set the Speed of the exhaust air, in this way, there are 4 period times that can be set. it can be exited automatically without operation for 15 seconds after setting is completed, or the short press mode button to exit.

7).Timed On/Off function: set the on / off time of equipment operation.

When the device is turned on, long press the Up button in any interface for 3 seconds to turn on the Timed On-Off function. The icon  is displayed when the device is turned on, the icon  is displayed when device is turned off. Long press the Up button again to turn off the timed On-Off mode. Long press the Down button to turn on the timed On-Off time setting, then the icon  flash, after short press the Up and Down buttons to set hours, press the SET button again to set minutes. After Short Press the Up and Down buttons to set minute, then short press the SET button, then the icon  flash, repeat the preceding

steps and completed set the timed on/off, it can be exited automatically without operation for 15, or the short press MODE button to exit.

8).Setting positive and negative pressure

User can set the speed of the supply air and exhaust air separately. If the positive pressure is needed, the speed of supply air should be higher than the speed of exhaust air; if the negative pressure is required, the speed of exhaust air should be higher than the speed of supply air; the specific speed difference is adjusted according to the actual situation.

9).Display of original air temperature, supply air temperature, CO2 concentration and humidity

When it is turned on, long press the MODE button in any mode for 3 seconds, OA temperature, SA temperature, indoor humidity (RA) and indoor Co2 concentration (RA) will be displayed alternately, the display interface is as follows. Short press the MODE button or 60 seconds without operation will exit the display interface. (Note: The RA temperature is often displayed under the conventional interface)

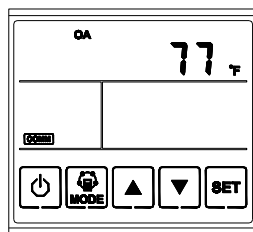

OA Temperature

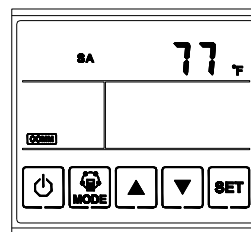

SA Temperature

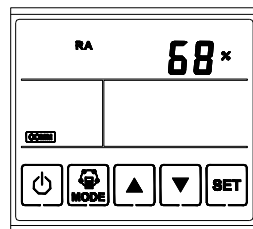

Indoor Humidity

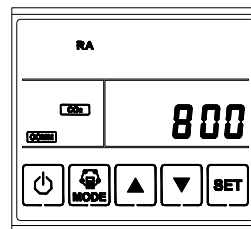

CO2 Concentration

10).Cleaning Alarm of Filter and Heat Exchanger

Logic principle: Through the countdown or differential pressure switch ways, remind to replace or clean the filter or heat exchanger. When the differential pressure switch function is turned off, the countdown mode works; When the differential pressure switch function is turned on, the differential pressure switch signal shall prevail.

Operation method: When the countdown time is up, the alarm icon of the filter or heat exchange flashes. When the differential pressure switch gives the signal, the filter and heat exchanger alarm icon flash at the same time (countdown or differential pressure function can be set in the parameter); Filter alarm countdown time (range 60-180 days) through the parameter setting, each adjustment of the up and down buttons is 10 days; Heat Exchanger alarm countdown time (range 120-360 days) can be set by the parameter, and each adjustment of the up and down buttons is 20 days; When use the countdown way, it can be reset by long pressing the On/Off button+ Mode button for 3 seconds. After the reset, the icon disappears and the time is recalculated; If the customer uses the differential pressure switch, when the differential pressure switch does not alarm, the filter alarm icon will disappear.

11). Intelligent air volume compensation (PS: only applicable to the highest speed):

During the long-term operation of the equipment, the filter screen will accumulate dust and gradually block, which will lead to the increase of equipment resistance and the decrease of air volume. In order to make up for the air volume loss, the air volume will be increased along with the regular pressurization of the supply and exhaust fans (the pressurization percentage can be set in the parameter item). The pressurization will be conducted once every 40 days for the supply fan and once every 80 days for the exhaust fan; When the filter screen is cleaned and the filter icon disappears, the air volume compensation is cleared. (The cumulative pressurization cannot exceed the maximum control voltage)

12). Temperature calibration (PS: No calibration may affect the judgment of anti-frost and automatic bypass functions)

When the measured value of the temperature sensor has a certain deviation from the actual value, it can be manually calibrated; The temperature and humidity values of the three air outlets can be calibrated through parameter setting.

13). Advanced sleep function (PS: this function is only applicable to sleep mode)

When the advanced sleep function is turned on in sleep mode, it will run according to the set speed (can be set in the parameter item, the default is speed 2); the starting condition is indoor temperature (RA) - outdoor temperature (OA) > set temperature difference (can be set in the setting in the parameter item), and outdoor temperature > set temperature (can be set in the parameter item); when the startup condition is not reached, the equipment runs in the original operating state.

Function : During the summer, the night purification mode draws cooler outside air into the room at night. This energy saving mode reduces the load when the air conditioner starts the next morning.

14). Fault display

When a fault occurs, the fault icon is displayed. In any interface, long press the Up button + Down button, and the temperature and humidity display position will display the fault code. In case of multiple faults, it will be displayed circularly.

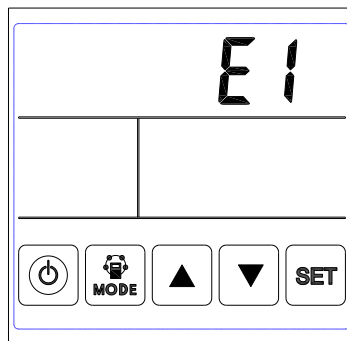

Display ternately

Fault Code

Code	Error
E0	Reserve
E1	SA fan error
E2	EA fan error
E3	OA temperature sensor error
E4	RA temperature sensor error
E5	SA temperature sensor error
E6	Fire fighting linkage error
E7	Humidity sensor error
E8	Co2 error
E9	Connection PCB board error

15). One button high speed

Application: In the kitchen or bathroom, the equipment can be turned on remotely through the rocker switch.

One remote rocker switch control interface is reserved on the mainboard. When the interface is connected, the supply fan and exhaust fan operate under the highest speed. At this time, the icon  flashes; When the interface is disconnected, the one button high speed mode stop and the equipment operate according to the previous status; It is not allowed to manually adjust the speed during the operation of one button high speed mode. Automatic speed adjustment is also not allowed.

16). CO2 strong exhaust (PS: does not start under sleep model)

No matter when the equipment is off or on, if the CO2 sensor detects that the CO2 concentration is higher than the setting value for more than 5 seconds, the equipment will run in the highest speed; when the CO2 concentration is lower than the setting value of 200, the equipment will return to the original running state; during CO2 strong exhaust, the CO2 icon will flash and the icon  will be displayed; during CO2 strong exhaust operation, manual and automatic speed adjustment are not allowed. (Note: The CO2 concentration setting value can be set in the parameter item)

17). Forced dehumidification (PS: does not start under sleep model)

No matter whether the equipment is off or on, if the humidity sensor detects that the humidity is higher than the setting value for more than 5 seconds, the equipment will run at the highest speed; When the humidity is 5% lower than the setting value, the equipment will return to the original running state; During forced dehumidification, the humidity value flashes and the icon  will be displayed; During forced dehumidification. manual and automatic speed adjustment are not allowed. (Note: the humidity setting value can be set in the parameter item)

18). Anti-frost (PS: not limited by mode)

When the fresh air inlet (OA) temperature is lower than -5°C (parameter can be set) for 1 minute, and the time from the last defrost exceeds 30 minutes (parameter can be set), the anti-frost function is turned on (the exhaust fan runs at high speed, and the supply fan stops at the same time, and the anti-frost icon will be displayed), the duration is 10 minutes (parameter items can be set), and then it returns to the original running state.

19). Ultra low temperature operation (PS: not limited by mode and prior to frost prevention)

① When the OA temperature is between -15°C and -10°C, the supply and exhaust fans run for 5 minutes, and then the exhaust fans operate separately for 10 minutes (the supply fan stop during this process), and then the supply and exhaust fans operate at the lowest level for 60 minutes, and then the exhaust fan operate separately for 10 minutes in sequence;

② When the OA temperature is lower than 5°F , the supply and exhaust fans operate for 5 minutes at the same time, then stop for 55 minutes at the same time, and then the supply fan operates separately for 5 minutes, and then the exhaust fan operates separately for 10 minutes, and this cycle is repeated.

Note: The ultra-low temperature exits when the temperature is greater than -10 degrees for more than 5 minutes.

20). Temperature adjustment function

0= fresh air heater(OA) and supply air heater(SA) are turned off at the same time.

1= The fresh air heater is off, the supply air heater is on,

2= The fresh air heater is turned on, the supply air heater is turned off, and the frost prevention and ultra-low temperature operation function are shielded.

3= fresh air heater and supply air heater turn on at the same time, to shield anti-frost and ultra-low temperature operation.

H1(P-Heat fresh air side OA electric heating) :

Starting condition:

When the $OA \leq (-5 \text{ to } -15^\circ\text{C})$ (adjustable, set in the secondary menu), for 1 minute, the OA heater starts, and the P-Heat icon turns on (OA heater off, P-Heat icon turns off).

When $OA < 25^\circ\text{C}$, turn off the heater for 10 minutes after turning on for 50 minutes, and execute the cycle

Exit conditions:

After the new wind electric heating starts,

When $OA(\text{fresh air temperature}) \geq 25^\circ\text{C}$, the electric heating is turned off, and the fresh air temperature is detected again 5 minutes later.

If $OA \geq 25^\circ\text{C}$, turn off the preheater;

If $OA < 25^\circ\text{C}$, start the electric heating; if $OA \geq 25^\circ\text{C}$, turn off the preheater (OA) and repeat for 5 minutes to detect the fresh air temperature; if $OA < 25^\circ\text{C}$, start the electric heating (PS: once here), and turn off the preheater after repeating for three times.

H2(R-Heat supply side SA electric heating) :

Turn into a single-speed electric heating, similar to the original control logic, press the " Δ " and " ∇ " arrow keys to set the electric heating opening temperature, the range is $16\text{-}30^\circ\text{C}$,

If $SA \geq$ set temperature, electric heating stops,

If the $SA <$ set temperature is lower than 1°C for 1 minute, the SA heater is turned on and the R-Heat icon is lit.

When $SA \geq$ set temperature, SA heater is turned off and R-Heat icon is turned off.

The SA electric heater temperature Settings are retained on the APP, and the OA electric heater Settings do not need to be reflected.

21). Power off memory

Logic principle: When the power supply of the equipment is suddenly cut off (such as power failure), the equipment shall be automatically started when it is powered on again and kept in the running state before power failure.

22). Restore factory settings

When the customer's parameter settings are chaotic, some parameters can be restored to the factory settings.

As some special parameters are set on the production line when leaving the factory, these parameters cannot be restored when restoring the factory settings: model, sensor selection, heating selection, auxiliary heating selection.

Operation: long press the power button + SET button

23). Engineering mode

Logic principle: In this mode, the manufacturer can customize the control voltage of air supply motor and exhaust motor at each speed.

Operation mode: Long press the "power button + down button" to enter the control voltage setting interface of the air supply and exhaust motor. The interface is shown as follows:

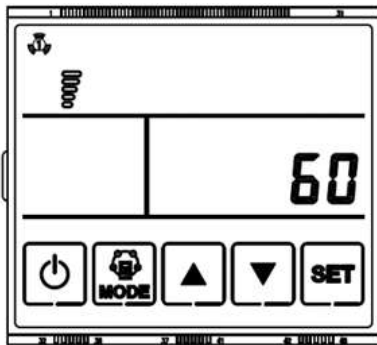

SA fan control voltage adjustment interface

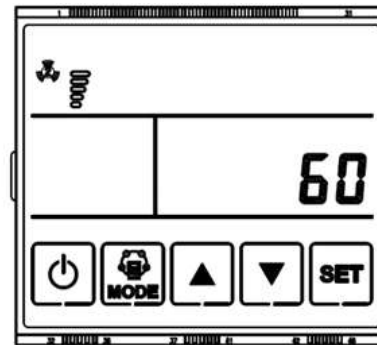

EA fan control voltage adjustment interface

After entering the voltage setting interface, first enter the control voltage setting interface of the air supply motor first. At this time, the icon  flashes. Click the SET button to switch speeds (1-10 speeds), and click the up and down buttons to adjust the voltage

When the air supply speed is at the 10th speed, click the SET button again to switch to the control voltage setting interface of the exhaust motor. At this time, the icon  flashes, and the setting method is the same as that of air supply; When the air exhaust speed is also at the 10th speed, click the SET button again to return to the control voltage setting interface of the air supply motor; After setting, it automatically save and exit without any operation for 15 seconds, or short press the mode button to save and exit.

24). Parameter table setting

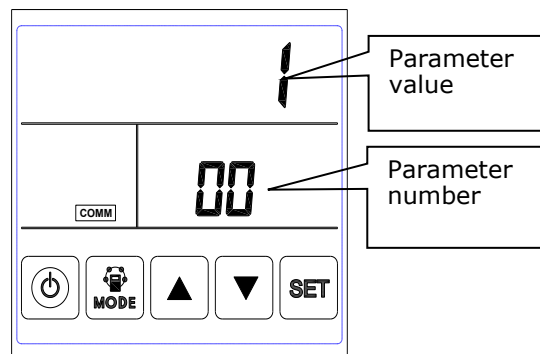

Setting parameters: long press the "power button + up button" for more than 6 seconds under the power on state, and then short the "SET" button. Each time you press it, the parameter value will be increased by 1 until the parameter 19 is displayed circularly. After selecting the corresponding parameter item, press the "△" and "▽" buttons to adjust the parameter value. After adjustment, press the "SET" button to switch to the next item.

Note: After adjustment, short press the power button to exit, or wait for 10 seconds to automatically exit and store. It takes about 15 seconds to store, and power cannot be cut off during this period

Operation Method

No.	Contents	Range	Default	Unit
P1	Centralized Control PC Address	1-99	1	
P2	Power to auto restart	0 - invalid, 1-valid	1	
P3	Auto Bypass	0 - invalid, 1-valid	0	
P4	Bypass opening temperature X	5-30	19	°C
P5	Temperature Deviation Y	2-15	3	°C
P6	Electric heating function setting	0: The OA and SA electric heaters are turned off at the same time 1: The OA electric heater is turned off and the SA electric heater is turned on 2: OA electric heating on, SA electric heating off, shield against frost and ultra-low temperature operation 3: OA electric heating and SA electric heating are turned on at the same time, shielding against frost and ultra-low temperature operation	0	
P7	Temperature of Electric Heating on	16-30	16	°C
P8	Frost Protection	0 - invalid, 1-valid	1	
P9	Defrost Interval	15-99	30	Minute
P10	Defrost Entering Temperature	+5~-9	-1	°C
P11	Defrosting Duration Time	2-20	10	Minute
P12	CO2 Sensor	0 - invalid, 1-valid	0	
P13	CO2 Threshold	800-2000	1500	ppm
P14	Humidity Sensor	0 - invalid, 1-valid	0	
P15	Humidity Threshold	50-100	70	%
P16	DC type selection	150、250、350 500、650、800 1000	150	
P17	Filter, Heat Exchanger alarm	1-Differential pressure switch, 2-Countdown	2	
P18	Filter Alarm Setting	60-180	60	Day
P19	Heat Exchanger Alarm Setting	120-360	120	Day
P20	Original Air Temperature Correction	±9	0	°C
P21	Supply Air Temperature Correction	±9	0	°C
P22	Return Air Temperature Correction	±9	0	°C
P23	Sleep Mode	1~10	1	
P24	Temperature Difference between Indoor and Outdoor	0~7	5	°C
P25	Set Temperature Setting	15~30	17	°C
P26	Percent Boost	1~10	0	%
P27	Fresh air heater startup setting value	-15~-5	-10	°C
P28	°F / °C Display selection	0-°C, 1-°F	1	

10. Communication protocol

Parameters: baud rate:9600, no check,1 digit stop position, 8 bit data.
 Support Function code: Read 03, write 06
 Communication data interval >=200ms

Register address	Read able	Writ able	Value range	Function description	Remark
0(0x0000)	03	06	0-1	on-off state , 0 - off 1 - on	
1(0x0001)	03	06	0-3	Mode 0-heat exchanger, 1-bypass, 2-Timing Auto 3-Sleep Mode	This parameter cannot be configured for a single dehumidifier.
2(0x0002)	03	06	0-10	Supply fan speed 1-20	
3(0x0003)	03	06	0-10	Exhaust fan speed	It may be reversed because of different model.
4(0x0004)	03		0	Reserve	
5(0x0005)	03		0	Reserve	
6(0x0006)	03	06	0-1	Humidity 1-on, 0-off	Some models do not support automatic
7(0x0007)	03	06	50-100	Humidity Critical Value	0 can not be written
8(0x0008)	03		0-99	Humidity Value	
9(0x0009)	03	06	0-1	CO2 Sensor, 1-on, 0-off	
10 (0x000a)	03	06	800-2000	CO2 Critical Value	
11 (0x000b)	03		0-0xffff	bit0: fire alarm protection Bit1: humidity sensor error Bit2: RA temperature sensor error Bit3: SA temperature sensor error Bit4: OA temperature sensor error Bit5: Motherboard forced start signal Bit6:Motherboard differential pressure signal Bit7:Filter Alarm Bit8: Air supply fan error Bit9: Air exhaust fan error Bit10: Replacing Filter Alarm Bit11:Mainboard forced high-speed signal Bit12: CO2 error Bit13:Motherboard forced bypass signal Bit14:-- Bit15:Not connected panel	
12(0x000c)	03		0-0xffff	bit0:The preheating function of the PCB board is enabled Bit1: The heating function of the PCB board is enabled Bit2:Ultra-low temperature logic 1 Bit3: The bypass function of the PCB board is enabled Bit4:The OA temperature error Bit5: The running signal of the motherboard is on Bit6: The error signal of the motherboard is on Bit7:The active power supply function of the PCB board is enabled Bit8: The motherboard's defrosting function runs Bit9:The fan is in a state of delayed shutdown after the main board is heated Bit10: The humidity exceeds the standard Bit11: The CO2exceeds the standard Bit12:Software bypass is enabled Bit13:-- Bit14:-- Bit15:--	

Communication protocol

Register address	Read able	Writ able	Value range	Function description	Remark
13(0x000d)	03		0-5000	Co2 Data	O can not be written
14(0x000e)	03	06	0-1	Electric Heating, 1-on, 0-off	
15(0x000f)	03	06	16-30	Setting electric heating temperature	
16(0x0010)	03		-30~+99	Supply Air Temperature	
17(0x0011)	03		-30~+99	Return Air Temperature	
18(0x0012)	03		-30~+99	Original Air Temperature	
19(0x0013)	03	06	-9~+9	Supply Air Temperature Correction	
20(0x0014)	03	06	-9~+9	Return Air Temperature Correction	
21(0x0015)	03	06	-9~+9	Original Air Temperature Correction	
22(0x0016)	03	06	0-1	Auto Bypass, 1-On, 2-Off	
23(0x0017)	03	06	2-15	Bypass return difference	
24(0x0018)	03	06	5-30	Bypass opening temperature	
25(0x0019)	03	06	0-1	Frost prevention, 1-on,0-off	
26	03	06	-9~+5	Defrost entering temperature	Use temperature control, defrosting type for detection defrosting. Use timing, from xx time after the start of defrosting.
27	03	06	10-99	Defrost interval	
28	03	06	2-20	Defrosting duration time	
29	03	06	0-250	Filter usage time/day (Current time will be cleared when writing 1)	Force timed defrosting when the exit temperature is set to 0
30	03	06	0-375	Heat Exchanger time/day (Current time will be cleared when writing 1)	
31	03	06	60-180	Filter alarm setting	
32	03	06	120-360	Heat Exchanger alarm setting	
33	03		1-2	Using differential pressure or timing, 1-using differential pressure,2-using timing	
34	03	06	0-7	The difference between Indoor and Outdoor	
35	03	06	1-10	Sleep Mode	
36	03	06	15-30	Setting Sleep Temperature	
37	03	06	0-1	Power to auto restart option,0-Power off to auto restart, 1-Power on to auto restart	
38	03	06	0-1	Child lock, 1-lock, 0-unlock	
39	03	06	1-99	Address	
40	03			moel: 150,250,350,500,650, 800,1000	
41	03	06	0-10	Intelligent boost coefficient, 0-off	

11 Maintenance



Warning

Before maintaining the system, cut off the power supply. Maintain the device after it stops completely to avoid damage.

Energy Recovery Ventilation (purification) needs regular cleaning and maintenance. If it is not cleaned and maintained correctly and regularly, its filtration efficiency and heat exchanger efficiency will be greatly reduced. Regular cleaning and replacement of the filter and heat exchange can effectively improve the filtration efficiency and heat exchange efficiency of the Energy Recovery Ventilation.

Cleaning primary filter and PM2.5 filter (optional) : It is recommended to clean 2 to 4 times a year (depending on the ambient air quality of different places, please decide the cleaning times by yourself according to the actual use time of the equipment).

The steps of taking out the heat exchanger and the primary filter (as shown in the figure below) :

1. Enter the ceiling by hand through the inspection port of the Energy Recovery Ventilation.
2. Remove the screws from the access door and open it;
3. Hold the handle of the heat exchanger and pull it out of the equipment;
4. After the heat exchanger is pulled out, remove the filter baffle at the guide rail of the heat exchanger, and then take out the primary filter.

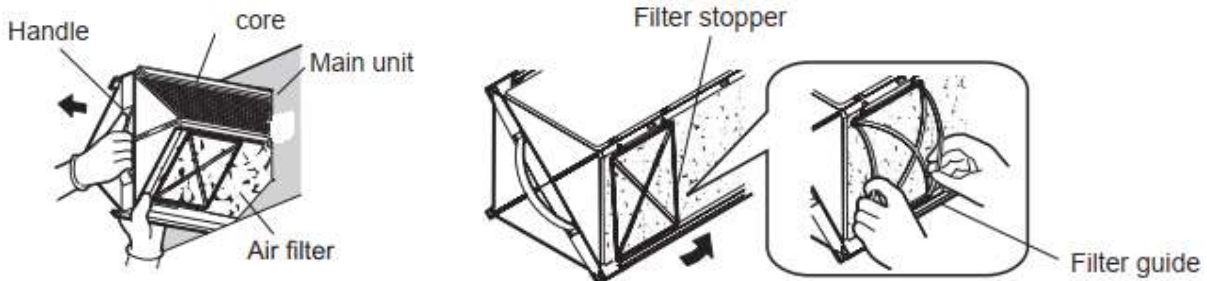
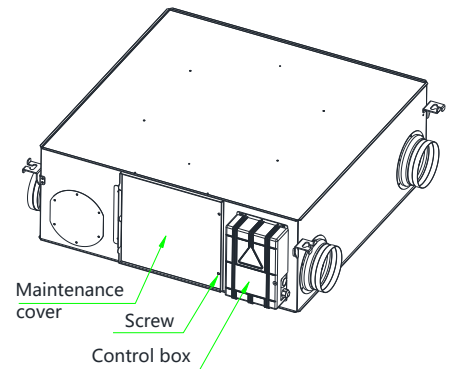

Maintenance method of heat exchanger and primary filter (as shown in the figure below) :

1. After the primary filter is removed, the dirt and dust can be removed gently by hand or vacuum cleaner; When dirty seriously can be soaked in detergent (neutral) warm water cleaning (below 40°); If dust accumulation is serious or damaged, it should be replaced in time.
2. The dirt and dust on the surface of the heat exchanger can be vacuumed with the suction nozzle, and water cleaning is prohibited;
3. After cleaning, reset the primary filter and baffle, install the heat exchange to the original place, and close the check cover.

Note: It is recommended to maintain the heat exchange every three years.

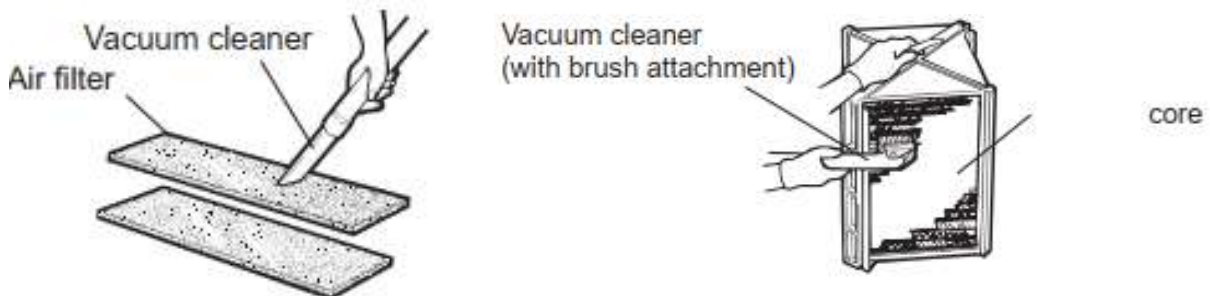

12 Failure diagnose

User can use the unit after trial operation. Before contacting us, you can make self trouble shooting following below chart in case of any failure.

Phenomenon	Possible reason	Solutions
The airflow volumes both indoor and outdoor vents drop obviously after a period of operation.	Dust and dirt blocking the filter	Replace or clean the filter
Noise comes from vents	Vents installation are losing.	Re-tightening the vents connections
Unit doesn't work	<ol style="list-style-type: none">1. No electricity2. Protection breaker is cut	<ol style="list-style-type: none">1. Guarantee power is on2. Connect the breaker



Tel.: +1 (514) 735-3539
Add.: 5965 Chem. de la Côte-de-Liesse
Saint-Laurent, QC H4T 1C3, Canada

